

wood stoves

Flamingo[®] DELUXE



**DESIGN THAT
CREATES WARMTH**

www.hsflamingo.com



Flamingo[®] DELUXE

Technical cross section

Flamingo DELUXE ®



- 1 Design that you desire
- 2 Top quality workmanship
- 3 A must-see flame
- 4 Glass must be clean... and so it is
- 5 Variable flame intensity control

olive

brown - velvet

grey



red

cream

black



Precise combustion control system

To achieve the highest possible combustion control, the stove utilises two draw bars to regulate primary and secondary/tertiary air supply.



External air supply

Significantly improves the combustion process in new buildings and "air-tight" rooms.

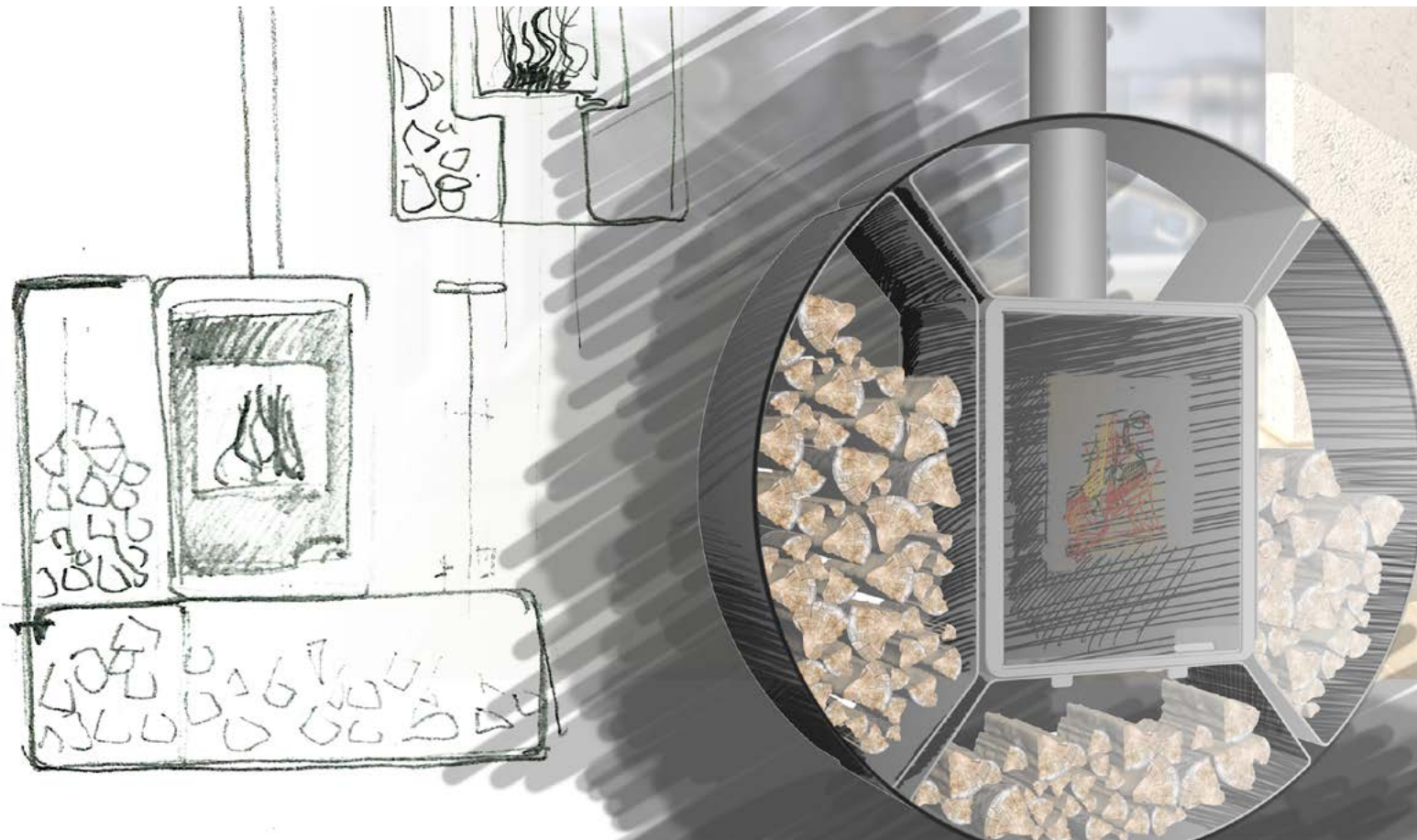

wood stove

malia



Simple installation on the wall using brackets

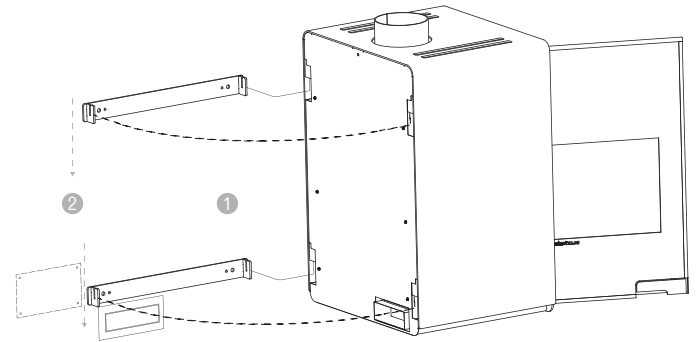

- + Top quality workmanship
- + Timeless design
- + Primary, secondary and tertiary air supply
- + Variable flame intensity
- + Insulated firebox from vermiculite
- + Ashtray

technical parameters

Nominal power kW	9
Nominal power range kW	3 - 11
Stove efficiency %	80.17
Fuel consumption kg/hour	2.9
Operating draught Pa	12 - 14
Smoke flue diameter mm	150
Log length cm	35
Weight kg	151
CO emissions (at 13% O ₂) %	0.077
Average flue gas temperature °C	287
Heating value m ³	60 - 220
Warranty	5 years

black

produced by HS Flamingo s.r.o.

www.hsflamingo.com

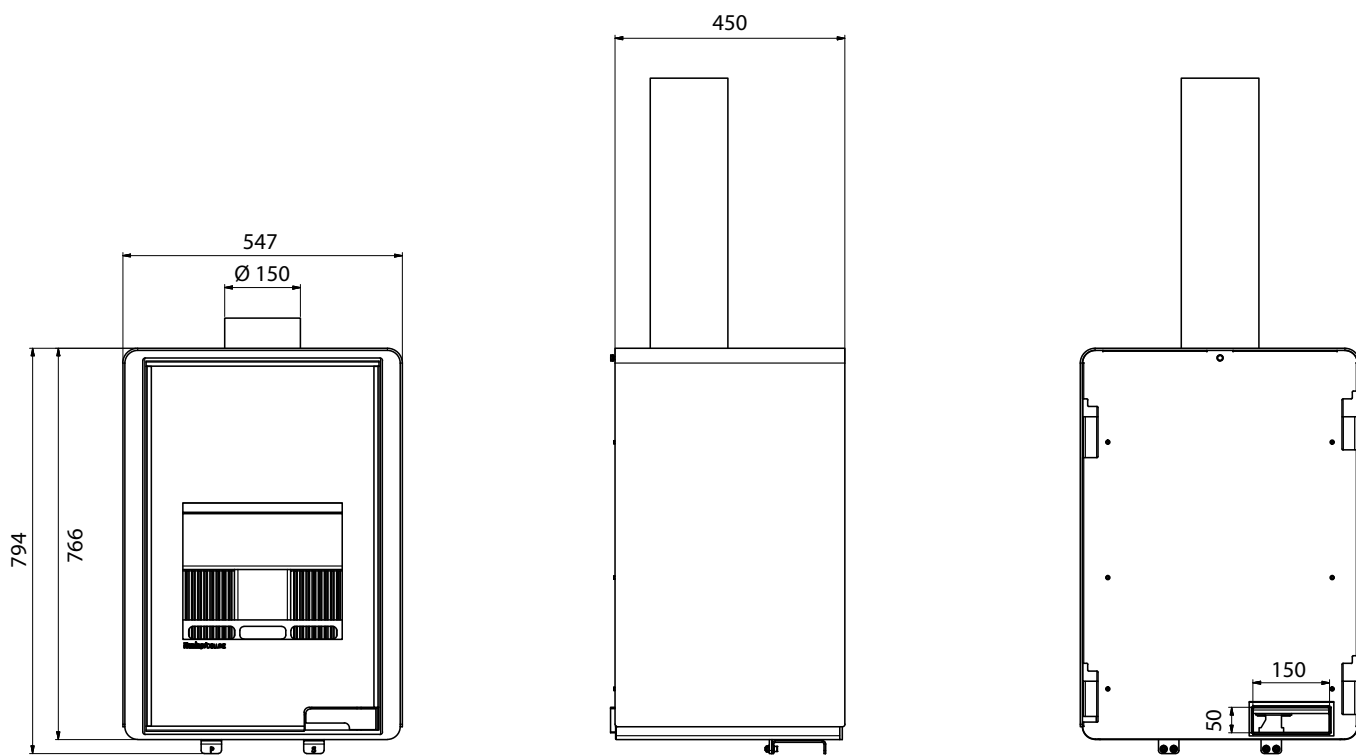

wood stove

pentai



technical parameters

Nominal power kW	9
Nominal power range kW	3 - 11
Stove efficiency %	80.17
Fuel consumption kg/hour	2.9
Operating draught Pa	12 - 14
Smoke flue diameter mm	150
Log length cm	35
Weight kg	176
CO emissions (at 13% O ₂) %	0.077
Average flue gas temperature °C	287
Heating value m ³	60 - 220
Warranty	5 years

- + Top quality workmanship
- + Timeless design
- + Primary, secondary and tertiary air supply
- + Variable flame intensity
- + Insulated firebox from vermiculite
- + Ashtray

red
brown - velvet
cream
olive
grey



black

produced by HS Flamingo s.r.o.

www.hsflamingo.com

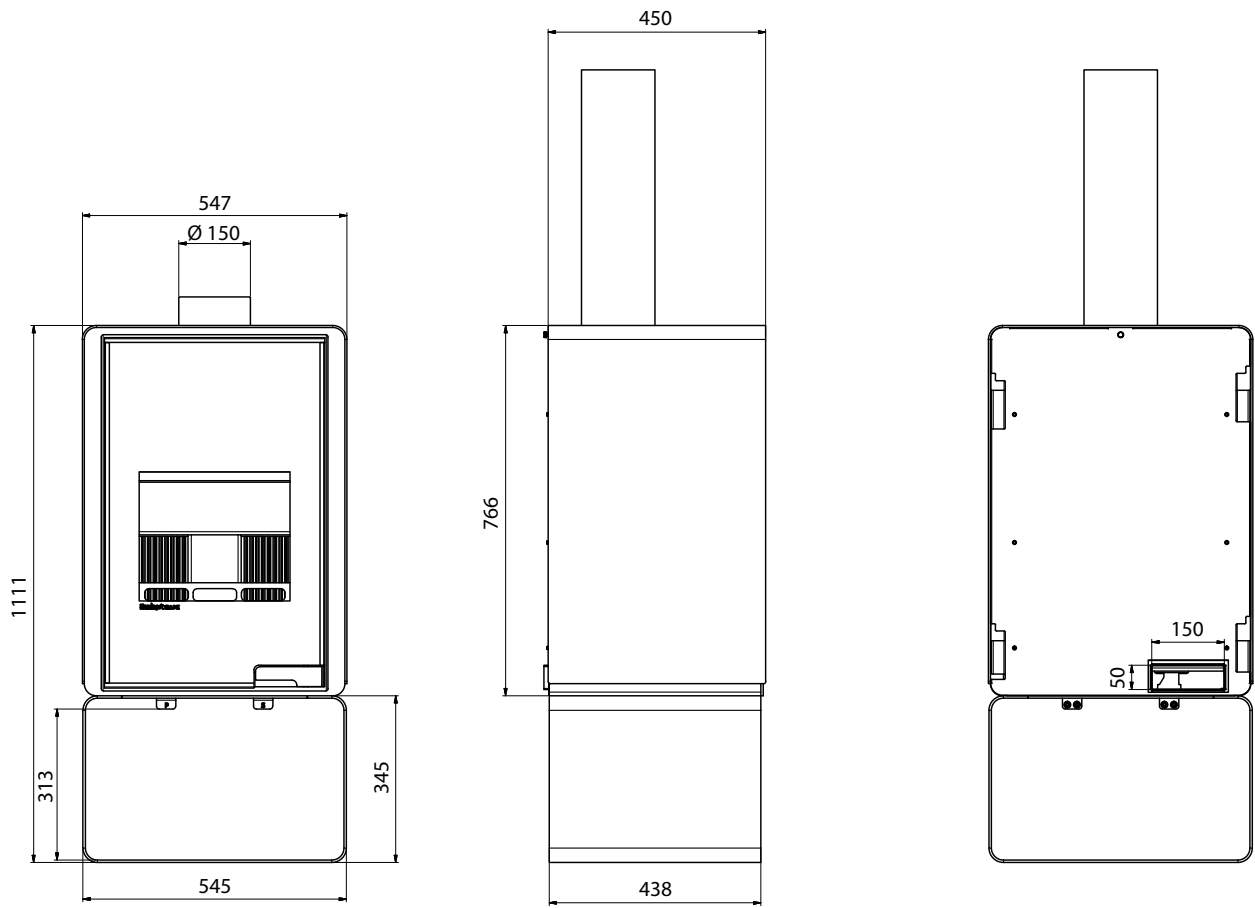





wood stove

kampa right



technical parameters

Nominal power kW	9
Nominal power range kW	3 - 11
Stove efficiency %	80.17
Fuel consumption kg/hour	2.9
Operating draught Pa	12 - 14
Smoke flue diameter mm	150
Log length cm	35
Weight kg	237
CO emissions (at 13% O ₂) %	0.077
Average flue gas temperature °C	287
Heating value m ³	60 - 220
Warranty	5 years

- + Top quality workmanship
- + Timeless design
- + Primary, secondary and tertiary air supply
- + Variable flame intensity
- + Insulated firebox from vermiculite
- + Ashtray

black
red
cream
olive
grey



brown - velvet

produced by HS Flamingo s.r.o.

www.hsflamingo.com

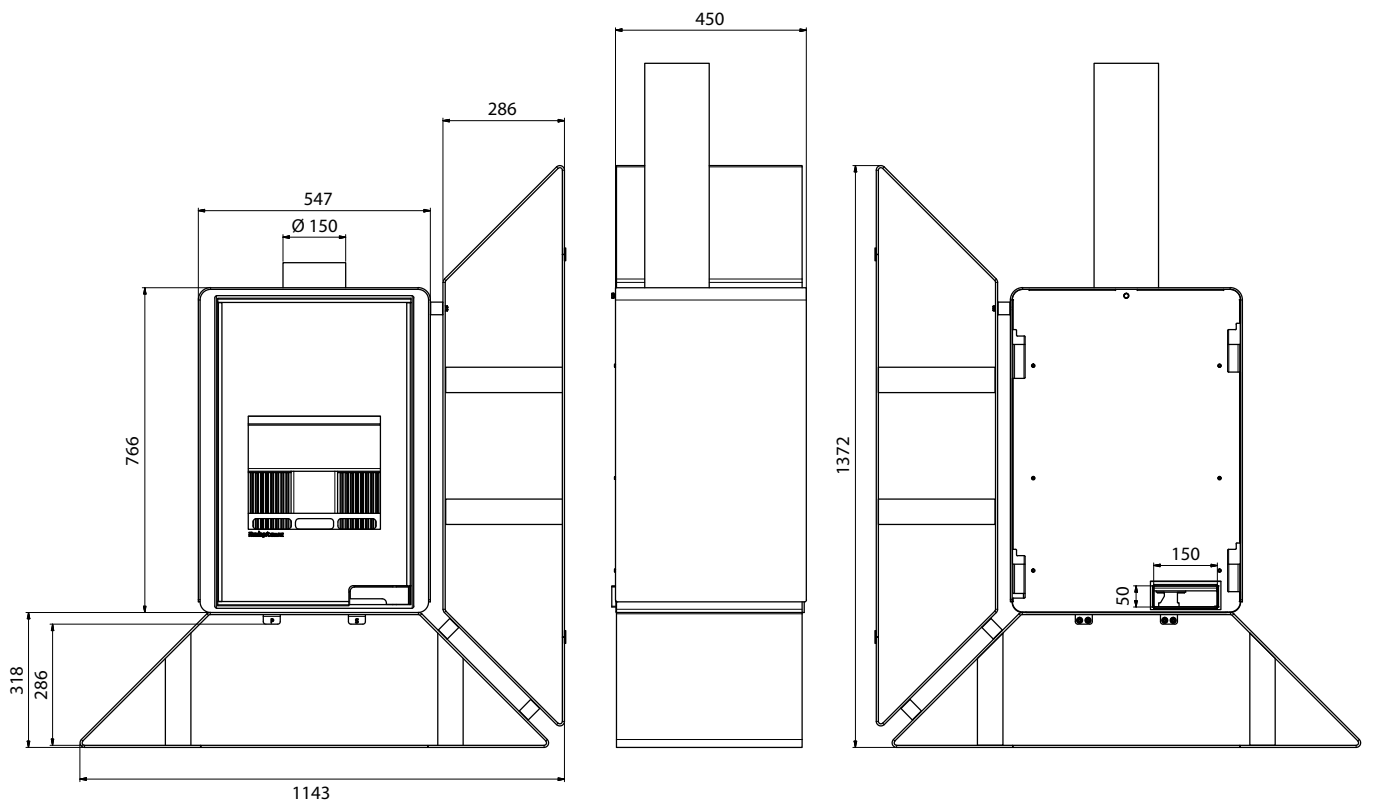





wood stove

kampa

left



technical parameters

Nominal power kW	9
Nominal power range kW	3 - 11
Stove efficiency %	80.17
Fuel consumption kg/hour	2.9
Operating draught Pa	12 - 14
Smoke flue diameter mm	150
Log length cm	35
Weight kg	237
CO emissions (at 13% O ₂) %	0.077
Average flue gas temperature °C	287
Heating value m ³	60 - 220
Warranty	5 years

- + Top quality workmanship
- + Timeless design
- + Primary, secondary and tertiary air supply
- + Variable flame intensity
- + Insulated firebox from vermiculite
- + Ashtray

black
red
brown - velvet
olive
grey



cream

produced by HS Flamingo s.r.o.

www.hsflamingo.com

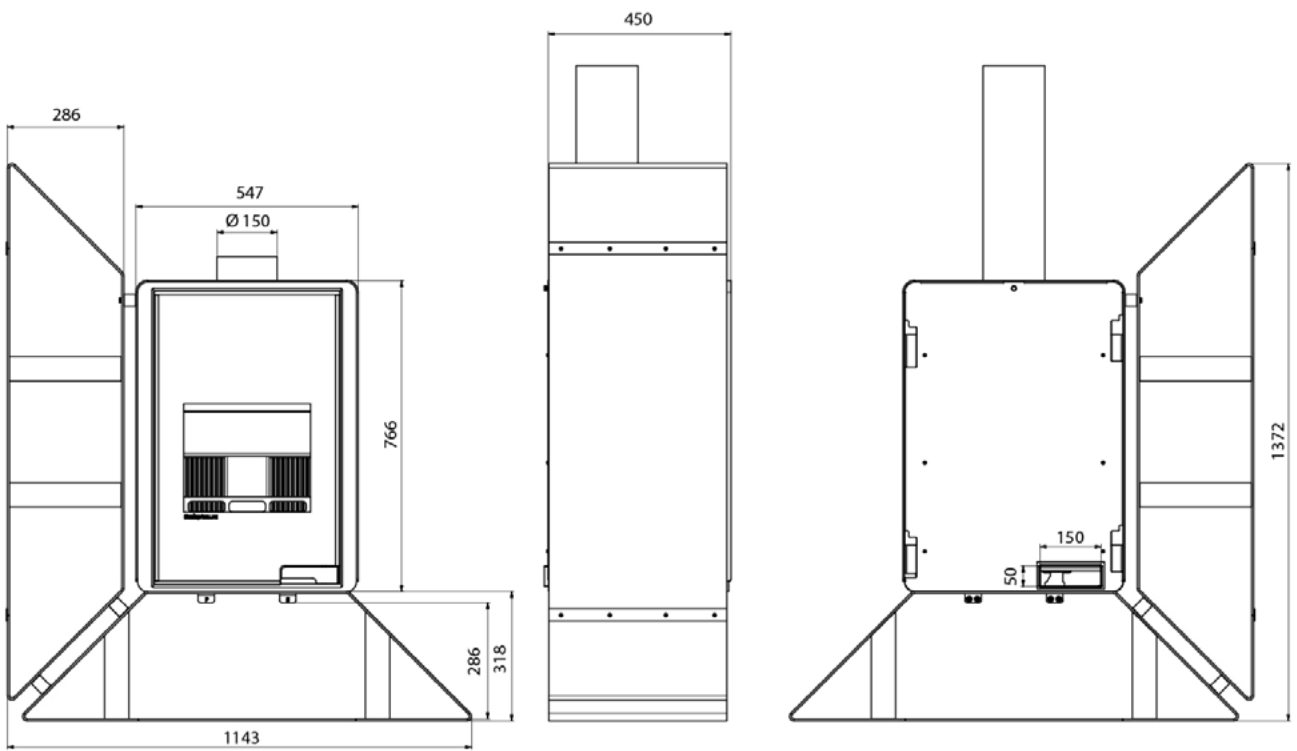





wood stove

senai



technical parameters

Nominal power kW	9
Nominal power range kW	3 - 11
Stove efficiency %	80.17
Fuel consumption kg/hour	2.9
Operating draught Pa	12 - 14
Smoke flue diameter mm	150
Log length cm	35
Weight kg	189
CO emissions (at 13% O ₂) %	0.077
Average flue gas temperature °C	287
Heating value m ³	60 - 220
Warranty	5 years

- + Top quality workmanship
- + Timeless design
- + Primary, secondary and tertiary air supply
- + Variable flame intensity
- + Insulated firebox from vermiculite
- + Ashtray

black
brown - velvet
cream
olive
grey



red

produced by HS Flamingo s.r.o.

www.hsflamingo.com

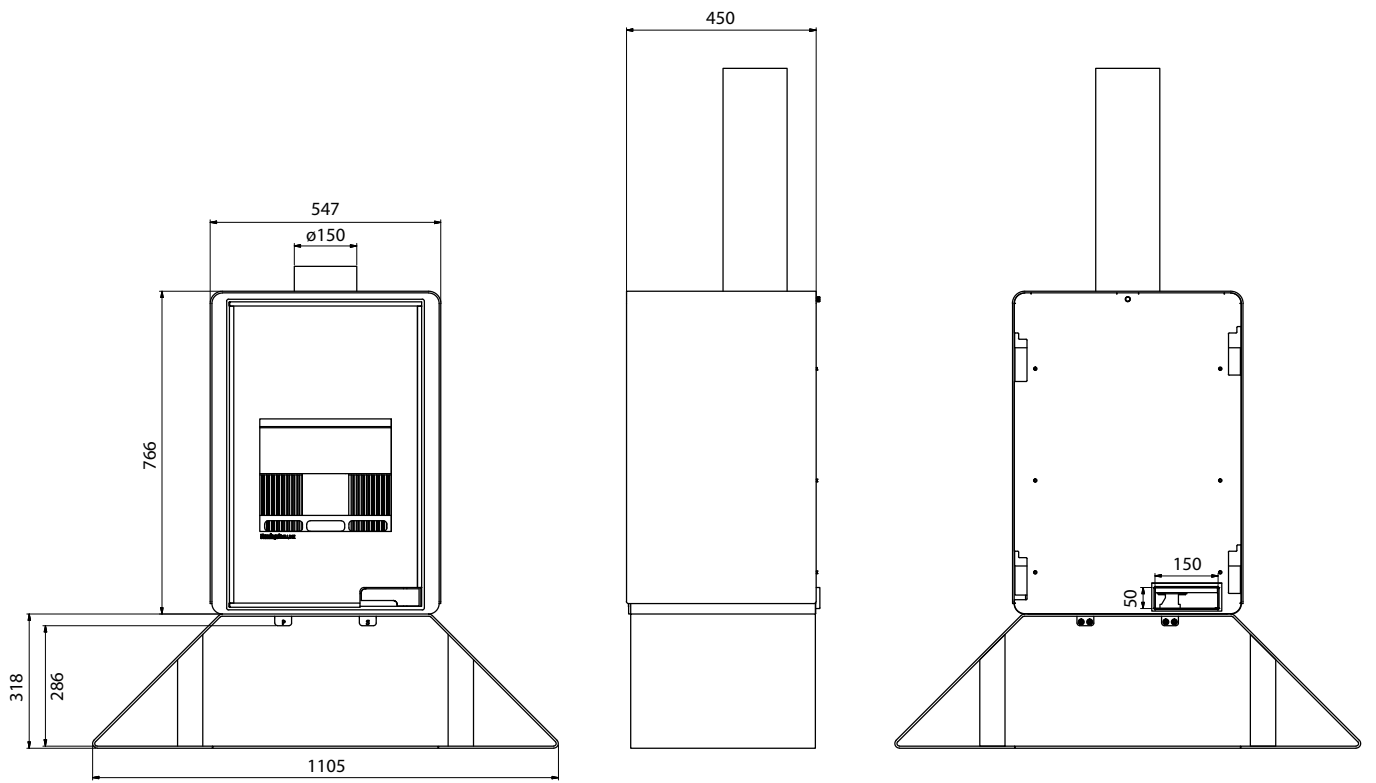





wood stove

singa



technical parameters

Nominal power kW	9
Nominal power range kW	3 - 11
Stove efficiency %	80.17
Fuel consumption kg/hour	2.9
Operating draught Pa	12 - 14
Smoke flue diameter mm	150
Log length cm	35
Weight kg	196
CO emissions (at 13% O ₂) %	0.077
Average flue gas temperature °C	287
Heating value m ³	60 - 220
Warranty	5 years

- + Top quality workmanship
- + Timeless design
- + Primary, secondary and tertiary air supply
- + Variable flame intensity
- + Insulated firebox from vermiculite
- + Ashtray

black
red
brown - velvet
cream
grey



olive

produced by HS Flamingo s.r.o.

www.hsflamingo.com

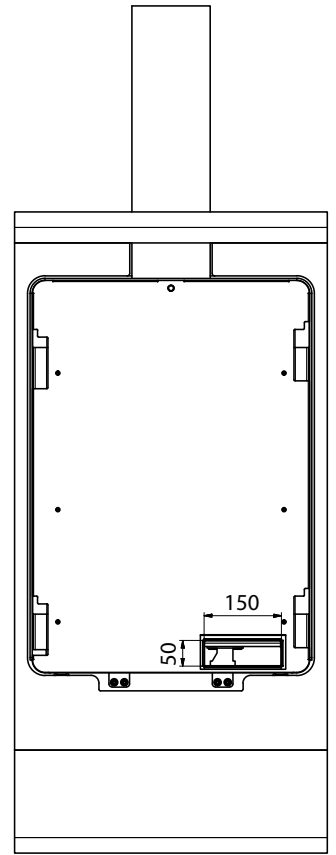
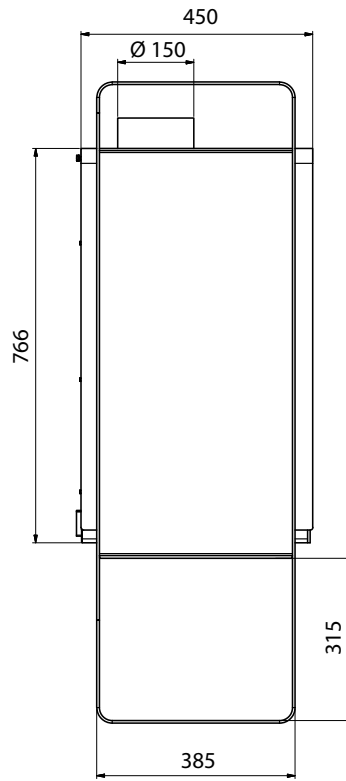
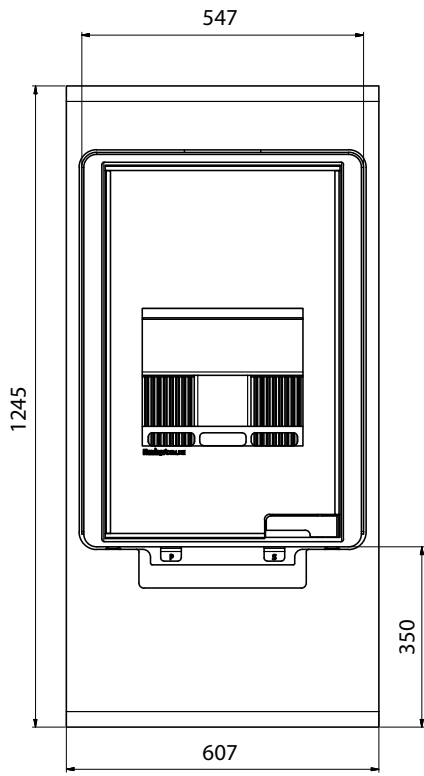





wood stove

island



technical parameters

Nominal power kW	9
Nominal power range kW	3 - 11
Stove efficiency %	80.17
Fuel consumption kg/hour	2.9
Operating draught Pa	12 - 14
Smoke flue diameter mm	150
Log length cm	35
Weight kg	180
CO emissions (at 13% O ₂) %	0.077
Average flue gas temperature °C	287
Heating value m ³	60 - 220
Warranty	5 years

- + Top quality workmanship
- + Timeless design
- + Primary, secondary and tertiary air supply
- + Variable flame intensity
- + Insulated firebox from vermiculite
- + Ashtray

black
red
brown - velvet
cream
olive



grey

produced by HS Flamingo s.r.o.

www.hsflamingo.com

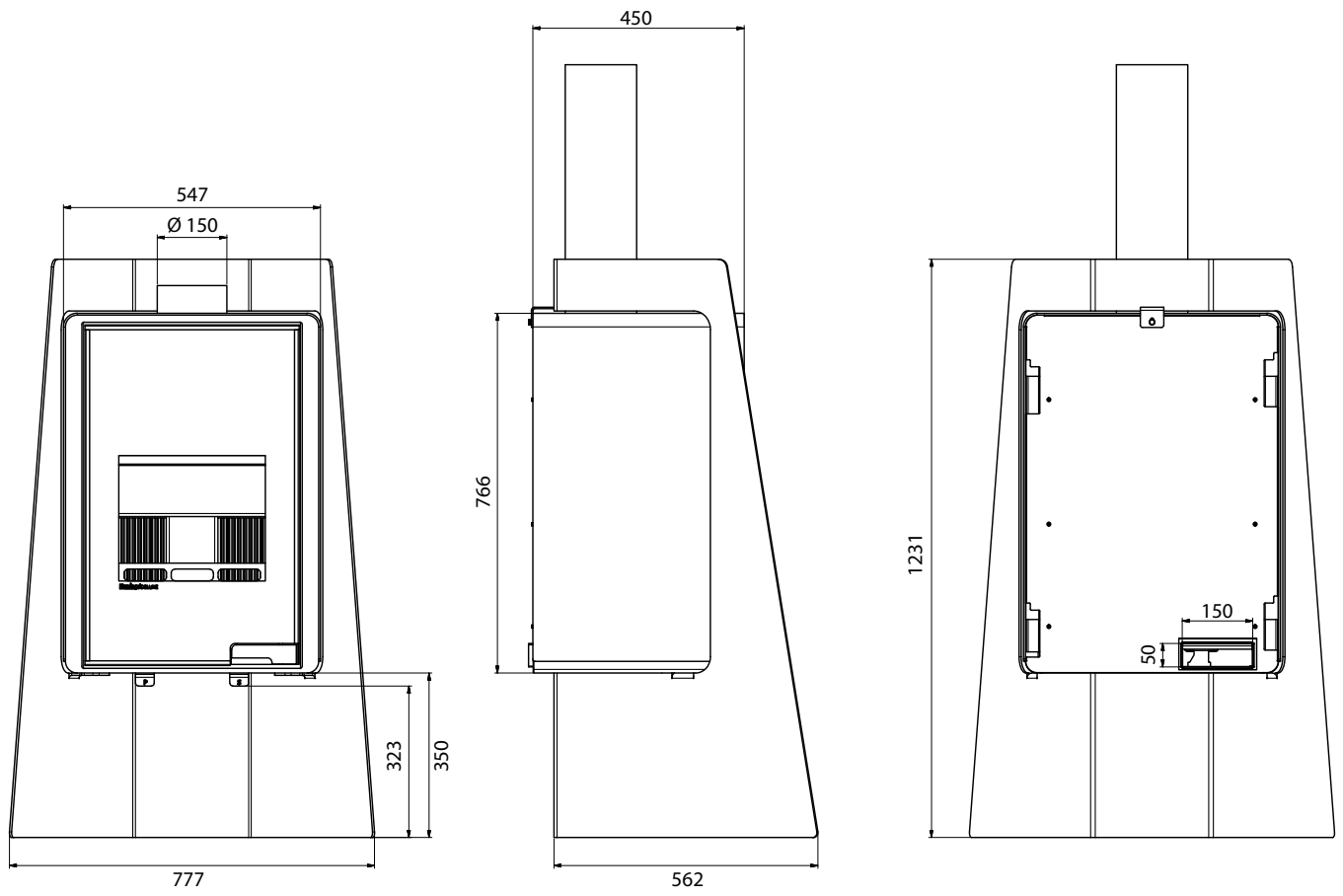





wood stove

pulau



technical parameters

Nominal power kW	9
Nominal power range kW	3 - 11
Stove efficiency %	80.17
Fuel consumption kg/hour	2.9
Operating draught Pa	12 - 14
Smoke flue diameter mm	150
Log length cm	35
Weight kg	170
CO emissions (at 13% O ₂) %	0.077
Average flue gas temperature °C	287
Heating value m ³	60 - 220
Warranty	5 years

- + Top quality workmanship
- + Timeless design
- + Primary, secondary and tertiary air supply
- + Variable flame intensity
- + Insulated firebox from vermiculite
- + Ashtray

black
brown - velvet
cream
olive
grey



red

produced by HS Flamingo s.r.o.

www.hsflamingo.com

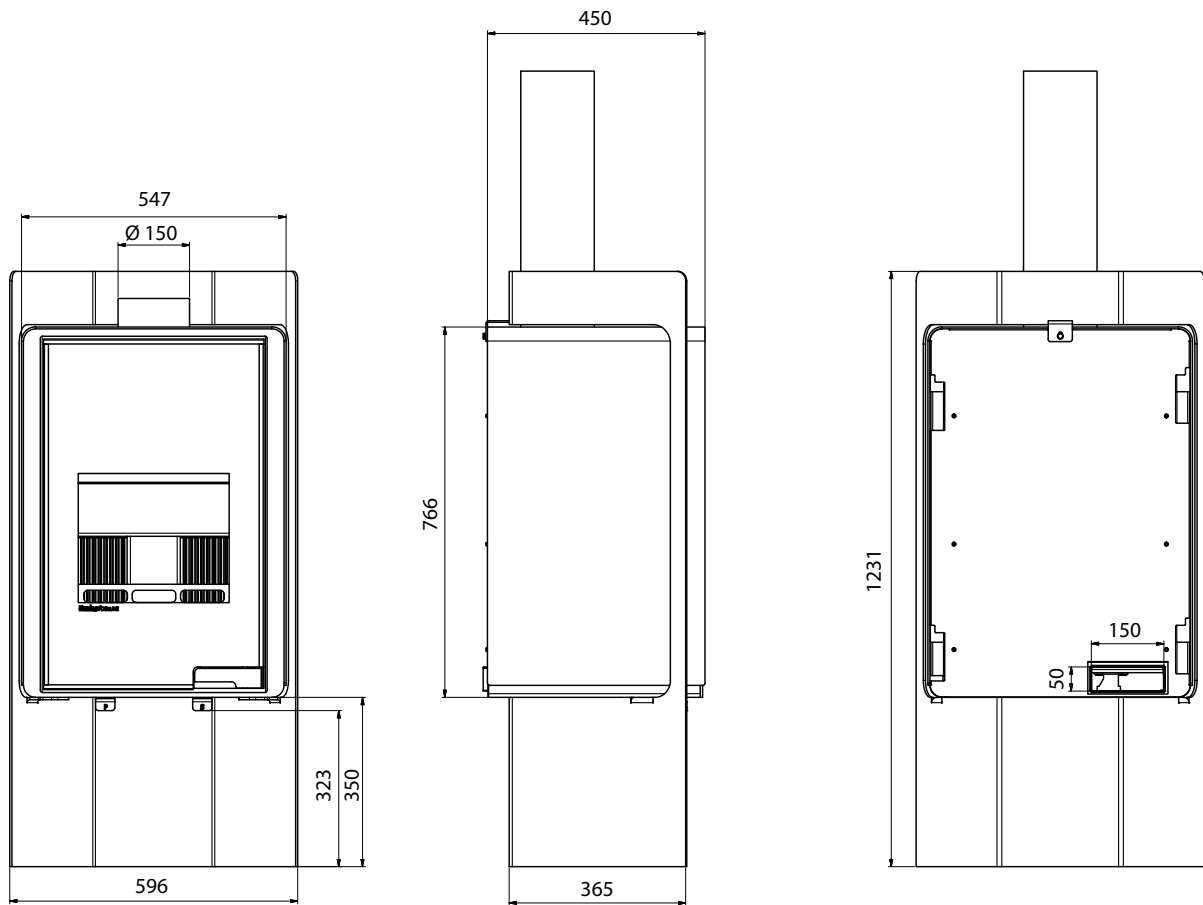





firewood rack

FD - 01



rack features

- + 5 mm metal sheet
- + Heat-resistant two-component paint
- + Same colours as other HS Flamingo products
- + 5 years warranty

black
brown - velvet
cream
olive
grey



red

produced by HS Flamingo s.r.o.

www.hsflamingo.com

firewood rack

FD - 02



rack features

- + 5 mm metal sheet
- + Heat-resistant two-component paint
- + Same colours as other HS Flamingo products
- + 5 years warranty

red
brown - velvet
cream
olive
grey



black

produced by HS Flamingo s.r.o.

www.hsflamingo.com

firewood rack

FD - 03



rack features

- + 5 mm metal sheet
- + Heat-resistant two-component paint
- + Same colours as other HS Flamingo products
- + 5 years warranty

black
red
brown - velvet
cream
grey



olive

produced by HS Flamingo s.r.o.

www.hsflamingo.com

firewood rack

FD - 04



rack features

- + 5 mm metal sheet
- + Heat-resistant two-component paint
- + Same colours as other HS Flamingo products
- + 5 years warranty

black
red
cream
olive
grey



brown - velvet

produced by HS Flamingo s.r.o.

www.hsflamingo.com

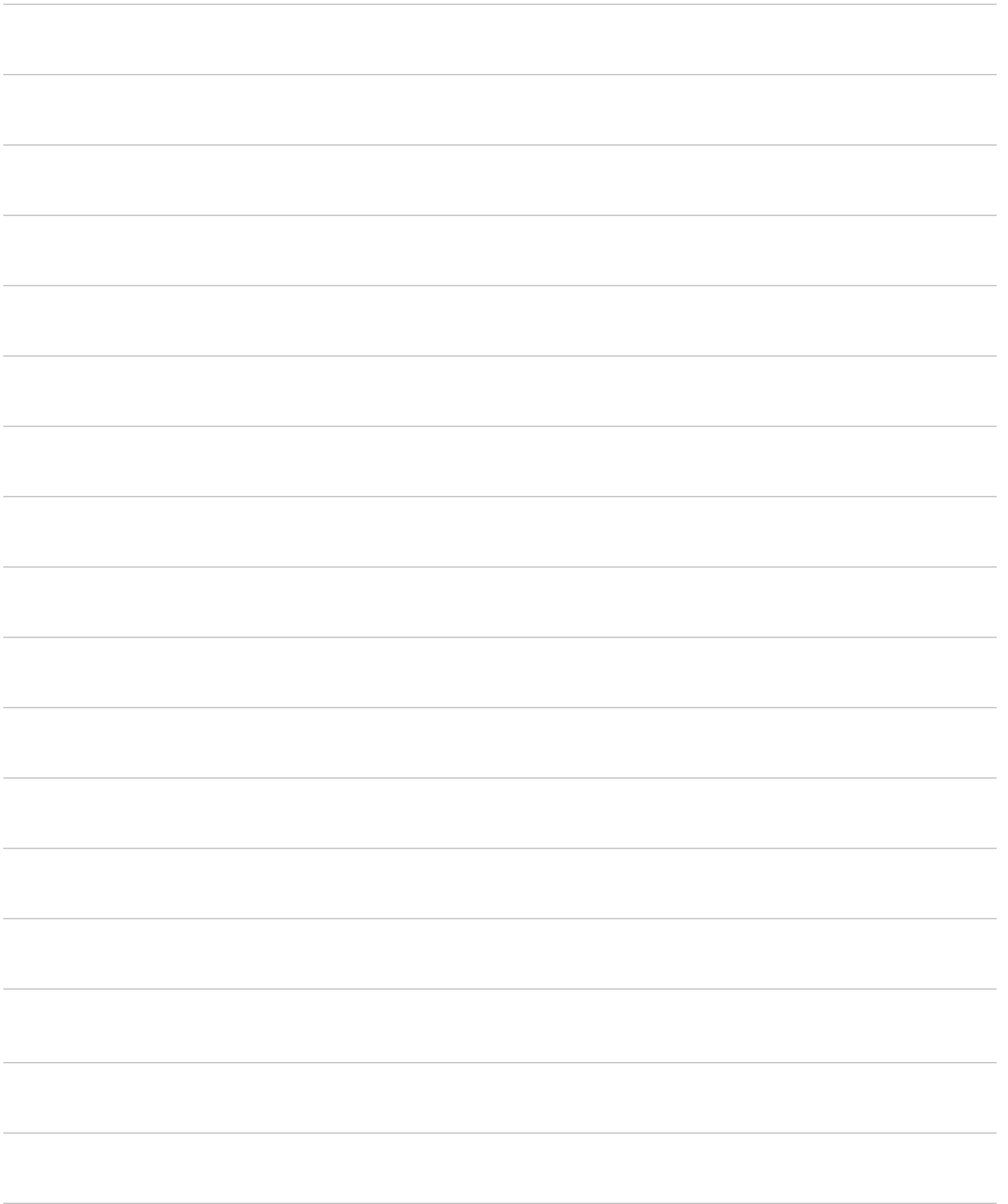

full product range at www.hsflamingo.com

Vendor:



HS Flamingo s.r.o.
třída Osvobození 65, CZ - 550 01
Broumov, Czech Republic

tel.: +420 491 422 647, fax: +420 491 521 140
e-mail: export@hsflamingo.cz

www.hsflamingo.com

Copyright © 2019 HS Flamingo s.r.o
072019